

The effect of elevated-temperature reverse cyclic loading on fracture toughness of aluminium alloy type 2618

D. BOBROW, A. ARBEL, D. ELIEZER

Department of Materials Engineering, Ben-Gurion University, Beer Sheva, 84105, Israel

Precipitation-strengthened aluminium alloy type 2618-T61 was subjected to symmetric and tension–hold reverse strain-controlled cyclic loading at 150 °C. The symmetric cyclic loading did not affect the resultant fracture toughness of the alloy but the tension–hold loading did. The reduction in fracture toughness was related to weakening of the grain boundaries by the prior tension–hold type of reverse loading.

1. Introduction

Modern designs of energy-generating installations which operate at high temperatures use information related to tensile, creep, low-cycle and high-cycle fatigue, fatigue crack propagation, time-dependent crack growth and fracture toughness of candidate materials to be used in such installations. High-temperature mechanical loading can introduce microstructural changes in crystalline materials such as: (1) nucleation, growth and migration of new phases; (2) dimensional and morphological changes, migration and disappearance of old phases; (3) grain-boundary sliding and migration; (4) formation of subgrains; (5) changes of dislocation density, configuration and distribution; (6) nucleation, growth and coalescence of grain-boundary voids; and (7) migration of undesirable elements to grain boundaries. Some of the aforementioned microstructural changes are interdependent, some will take place due to mere exposure to elevated temperatures, while others may be accelerated by high-temperature loading and some will not occur at all without mechanical loading. Some of the above changes may cause reduction in fracture toughness of materials to dangerous values well below those which these materials had before being put into service. Thus, a situation may arise whereby the fracture toughness of materials, which serve at high temperatures, may become dangerously low long before these materials exhausted their lives as determined by other life-prediction methods.

It was therefore suggested that safe life of materials which serve while loaded at high temperatures should be determined by their resultant fracture toughness rather than by other conventional methods [1]. Two exploratory investigations showed that the formation and coalescence of grain-boundary voids caused detrimental reductions in fracture toughness of a solid solution and precipitation-strengthened nickel-base superalloys long before they approached the end of their creep lives [1, 2]. Intergranular and intragranular carbides which formed during the early stages of

exposing 316 stainless steel to a high-temperature soak and to creep, were considered as the main contributors to the observed reductions in uniform and total tensile elongations and to the decrease in impact energy needed to fracture Charpy keyhole specimens [3]. Constant and cyclic tensile creep did not cause any formation of voids along grain boundaries of a properly precipitation-strengthened aluminium alloy type 2618 (RR 58) [4]. The observed slight reduction in fracture toughness of this alloy was related to the increase of dislocation density which took place during the preceding creep process [4]. Grain-boundary voids were formed during creep and caused considerable reduction in fracture toughness of the same aluminium alloy when it was heat treated initially in such a way so that precipitation-free zones formed along its grain boundaries [5]. The purpose of this work was to study the effect of elevated-temperature reverse cyclic loading on the resultant fracture toughness of a model material for strong, properly and uniformly precipitation-strengthened polycrystalline alloy which does not form grain-boundary voids during constant or cyclic tensile creep loading.

2. Experimental details

The commercial precipitation-strengthened aluminium alloy type 2618-T61 was selected for this study. The alloy was received in the form of extruded 152 mm diameter stock bar. Segments were cut from the bar, solution treated for 2 h at 525 °C followed by a quench into water at 75 °C and then aged for 20 h at 200 °C. Low-cycle fatigue-type specimens, as shown in Fig. 1 were machined from the heat-treated alloy. The location and orientation of all the specimens were the same with respect to the original 152 mm diameter extruded stock bar of the alloy from which all the specimens were machined. This procedure was employed in order to minimize any variations in mechanical behaviour due to any eventual anisotropy and/or inhomogeneity in the original stock bar. The location

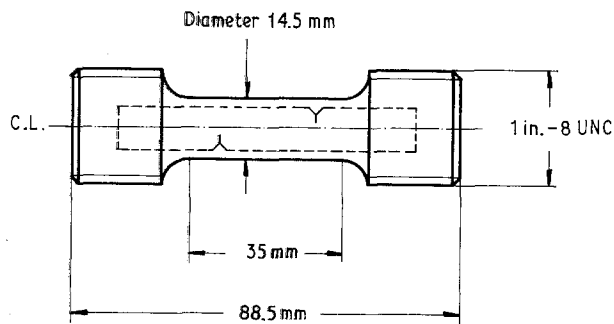

Figure 1 Specimen for reverse cyclic loading with the secondary specimen for fracture toughness (dashed lines).

of the secondary specimen, which was machined from the original fatigue-type specimen for studying the resultant fracture toughness of the alloy, is also depicted by the dashed lines in Fig. 1.

Strain-controlled reverse cyclic loading, with the aid of elevated-temperature longitudinal extensometer of 25 mm gauge length, was carried out in a servo-hydraulic testing machine inside a three-zone furnace where a temperature of $150 \pm 1^\circ\text{C}$ was maintained. This temperature was selected because it did not seem to affect either the morphology and the size of the precipitates in this alloy or its tensile properties and fracture toughness after soaking for periods longer than the durations of the reverse cyclic loading [4]. Thus, we reduce the number of microstructural changes which take place during loading. Two types of loading cycles were employed, both having a total strain range of 1.2%. One cycle was strain-symmetric with equal loading and unloading rates of $2.4 \times 10^{-3} \text{ s}^{-1}$. The second type of cycle had the same loading and unloading rates as before, but it also included an additional hold-time in tension. A two-notch three-point bend fracture toughness specimen was machined from each original reverse loading specimen. A sharp fatigue precrack was introduced at the root of each of the notches in the bend specimens. The dimensions of the bend specimens and the method of their loading are depicted in Fig. 2a. The load, F , was applied at a constant mid-point deflection rate of 1 mm min^{-1} . A typical load versus mid-point deflection curve is shown in Fig. 2b. W/A (in Fig. 2), which is the amount of energy, per unit area of the remaining ligament, spent to bend the pre-cracked specimen beyond the peak of the load-deflection curve and down to a load equal to one-tenth of the peak load, was adopted as the measure of the resistance of the alloy to extension of sharp cracks or its fracture toughness. This measure was used because it had shown good correlation with fracture toughness as determined from valid specimens made of similar aluminium alloys [6]. Fracture surfaces of the secondary specimens were examined by scanning electron microscopy and the bulk of the alloy was studied with the aid of transmission electron microscopy.

3. Results and discussion

Figs 3 and 4 depict the nature of the reverse symmetric and reverse tension-hold time loading cycles, respect-

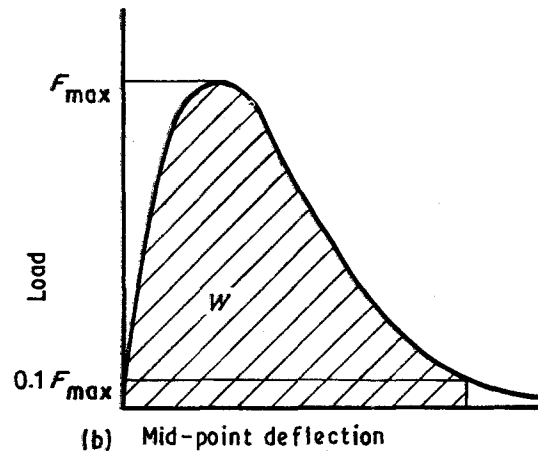
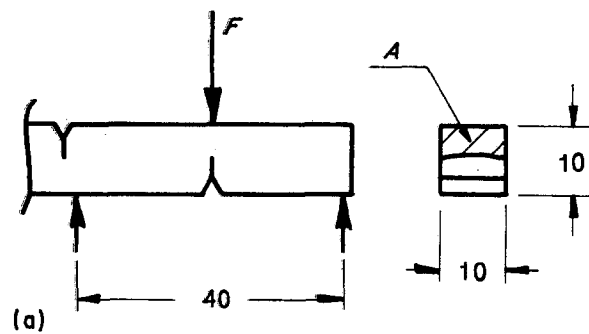
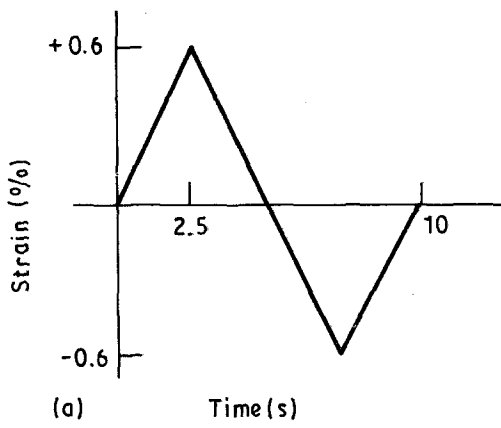

Figure 2 (a) Three-point bending of the double-notched and pre-cracked fracture toughness specimen and its dimensions; (b) typical load-mid-point deflection curve of the specimen in (a).

ively. The stress versus time curves deviated from linearity because the alloy was deformed plastically. The initial extreme values of the tensile and compression stresses of the reverse symmetric cyclic loading were $+346$ and -335 MPa, respectively. Gradual softening was observed with the extreme values of the stresses reaching $+312$ and -316 MPa upon approaching 1000 cycles. The tension-hold time interval shown in Fig. 4a resulted in stress relaxation depicted by δS in Fig. 4b and it was equal to 55 MPa. Softening of the alloy was also observed in the tension-hold cycles. The alloy was subjected to up to 3000 symmetric cycles without the initiation of fatigue cracks which would be detected by a reduction in the peak tensile stress of the cyclic stress versus strain loop in Fig. 3c. The time required to complete 3000 symmetric cycles was 8.34 h. As seen in Fig. 5, the symmetric cyclic loading did not seem to affect the fracture toughness of the alloy which had an initial average value of 14.7 kJ m^{-2} .

The alloy failed by fatigue crack initiation and propagation after 1810 reverse cycles which included a tension-hold period as depicted in Fig. 4a. The time to complete these 1810 cycles was 151.3 h. The tension-hold reverse loading cycles caused gradual reduction of the fracture toughness of the alloy as shown in Fig. 5. The effect of the expended fraction of fatigue life on the resultant fracture toughness of the alloy is depicted in Fig. 6. The plane of the precrack in the



(a) Time (s)

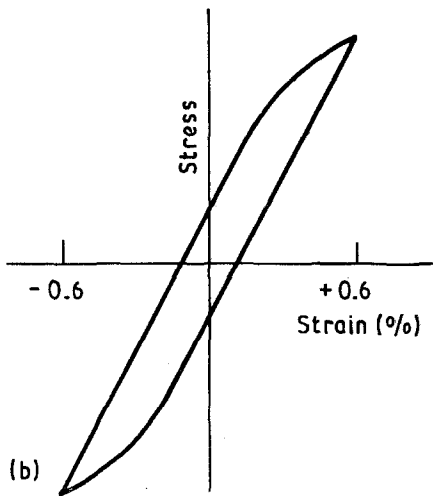

(b)

Figure 3 (a) Symmetric reverse cyclic loading strain versus time; (b) the corresponding load versus time cycle; (c) the resultant stress versus strain loop.

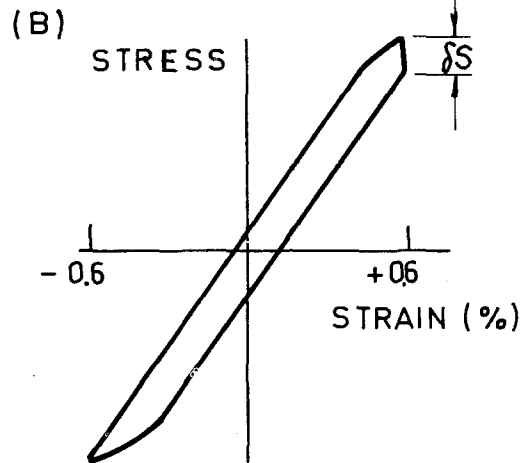
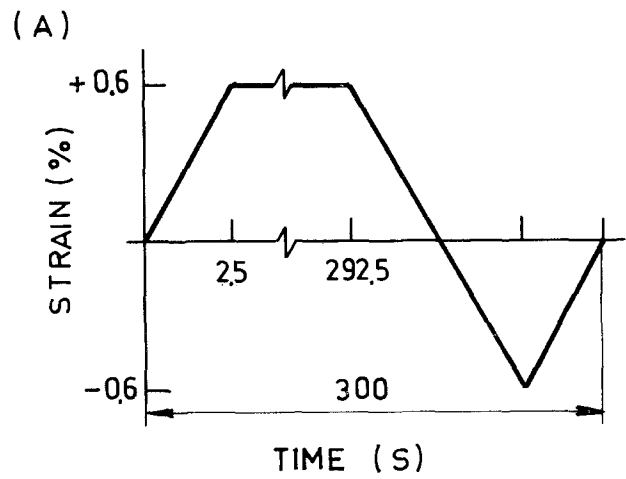

(B)

Figure 4 (a) Reverse cyclic loading strain with tension-hold versus time; (b) the corresponding stress versus time cycle; (c) the resultant stress versus strain loop.

secondary specimen prepared from the alloy, after it reached 1810 tension-hold cycles, was located some 22 mm away from the cross-section where the primary specimen failed by fatigue crack initiation and propagation.

Transmission electron microscopy revealed a slight increase of dislocation density due to the plastic component of the total strain range of the reverse cyclic loading. As previously [4], no changes were observed in the size or morphology of the precipitates. Thus, we can conclude that the microstructure inside the grains had little or no effect on any changes in the fracture toughness of the alloy. Scanning electron microscopic fractography of the bent and fractured precracked secondary specimens revealed that fracture in the virgin, as-heat-treated alloy, was predominantly dimpled intragranular with only about 3-4% of the fracture area being intergranular. This behaviour did not seem to be affected by the elevated-temperature symmetric loading. A typical intragranular fractured surface of the alloy is depicted in Fig. 7 with many of the small Al_2FeNi particles still situated at the bottom of the dimples. The tension-hold type cycles resulted in a gradual increase of the percentage of intergranular fracture area observed in the fractured secondary

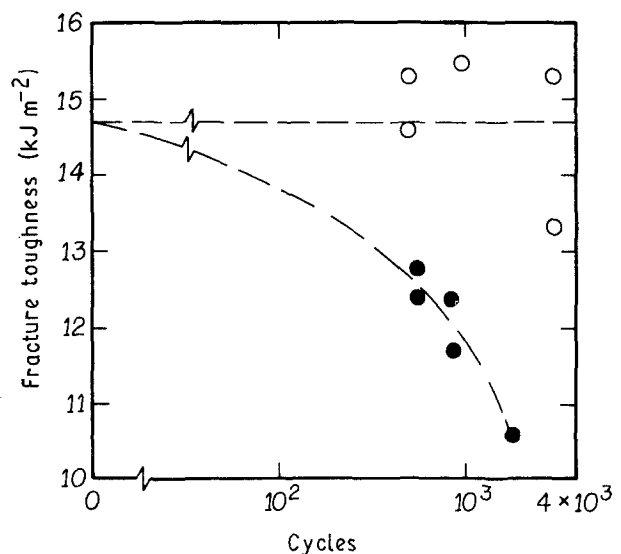

Figure 5 The dependence of the fracture toughness of the alloy on the number of prior reverse loading cycles: (○) symmetric, (●) tension-hold.

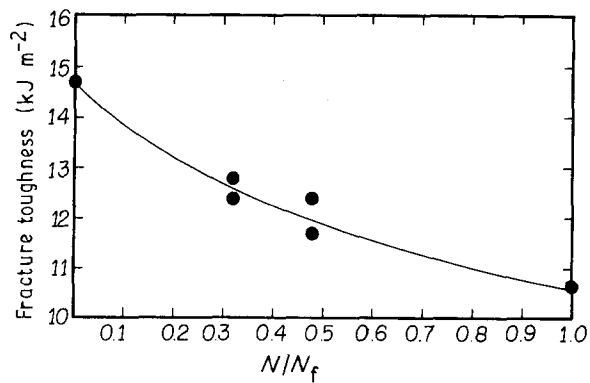

Figure 6 The resultant fracture toughness of the alloy versus the fraction of its fatigue life in reverse cyclic loading with tension–hold.

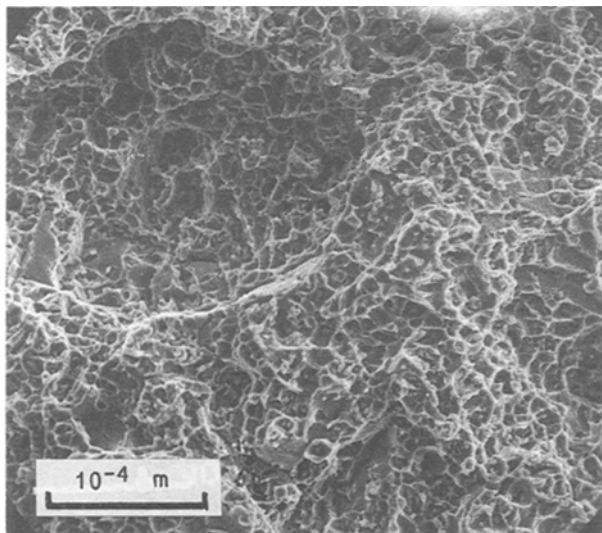

Figure 7 Typical dimpled intragranular fracture surface of the bent precracked secondary fracture toughness specimen after the alloy was subjected to symmetric cyclic loading.

specimens. Fig. 8 features fractured surfaces of secondary specimens which experienced prior tension–hold cycles. Fig. 9 shows the effect of the number of cycles on the percentage of intergranular fracture area observed in the secondary specimens used for determining the fracture toughness of the alloy after it was cyclically loaded at 150°C. As indicated earlier, symmetric loading did not seem to affect the amount of intergranular fracture. Fig. 10 shows the effect of the amount of intergranular fracture on the fracture toughness of the alloy.

The dimpled intragranular fracture involves a considerable amount of localized plastic deformation which in itself requires higher amounts of energy in order to fracture the precracked specimen as compared to the amount of energy, per unit area, needed for intergranular fracture. Therefore, the higher the percentage of the intergranularly fractured surface, the lower is the fracture toughness of the alloy. The tension–hold reverse loading cycle introduced, by as yet an unclear mechanism, damage which resulted in increased amount of intergranular fracture during the bending of the precracked secondary specimens. The

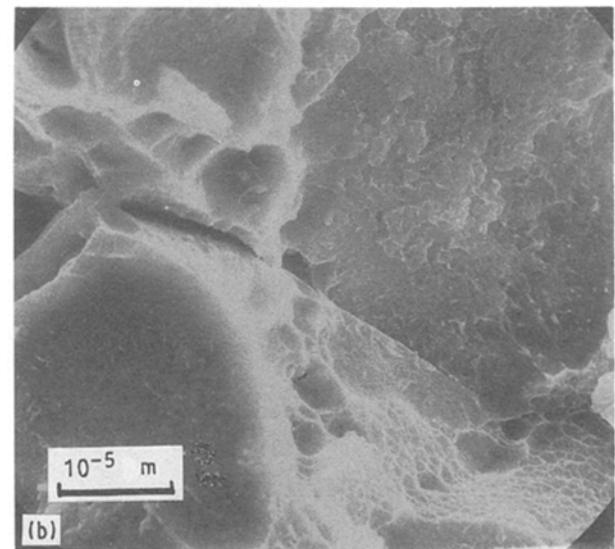
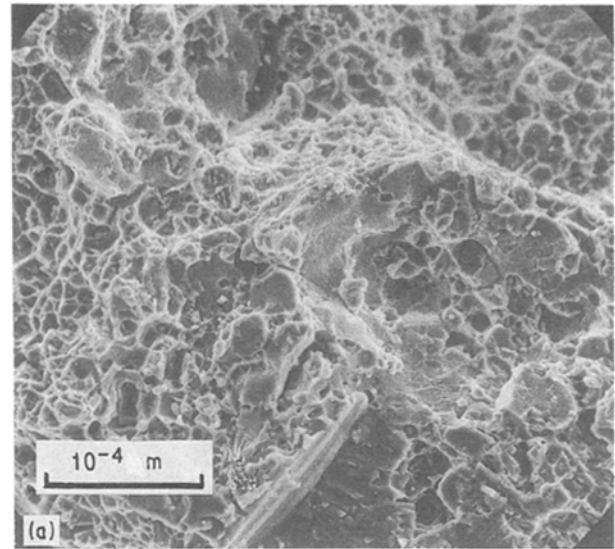

Figure 8 (a) Scanning electron microscopic fractography of precracked and bent secondary specimen made of the alloy after it was subjected to tension–hold reverse cyclic loading; (b) enlargement of (a) showing separation along grain boundaries.

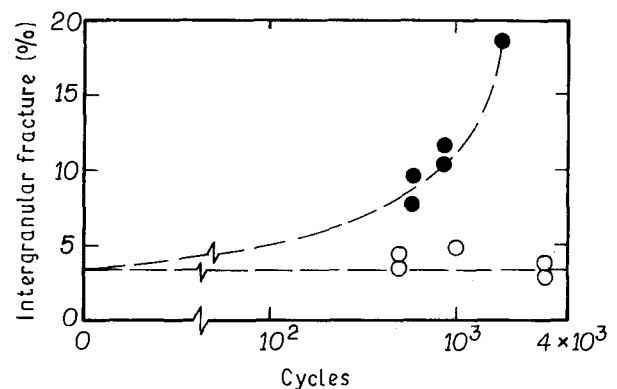

Figure 9 The effect of the number of prior cycles on the percentage of intergranular fracture in the precracked and bent secondary specimens: (○) symmetric, (●) tension–hold.

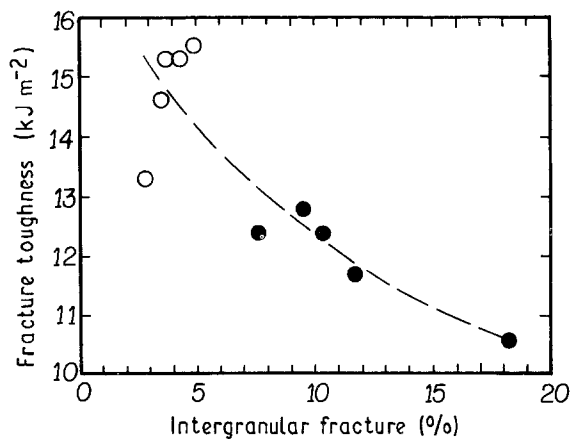

Figure 10 The effect of the percentage of intergranular fracture on the fracture toughness of the alloy: (○) symmetric, (●) tension-hold.

tension-hold portion of the cycle can be expected to introduce the kind of grain-boundary damage which will usually be caused by tension-creep. However, prior monotonic and cyclic tension-creep did not cause any increase in intergranular fracture as compared to the amounts observed in the virgin, as-heat-treated alloy [4]. Apparently, it is the combination of tension-hold and the complete reverse loading cycle that is responsible for a grain-boundary weakening effect which could not be caused either by the continuous tension-creep alone or by the symmetric reverse cyclic loading alone. Creep-fatigue interaction, at various temperatures and all the way to fracture, was studied on another precipitation-strengthened aluminium alloy [7]. Regardless of the shape of the loading cycle, fatigue crack initiation was always intergranular when the alloy was tested at 150 °C which is also the

temperature of our reverse cyclic loading. This behaviour is somewhat different from that observed by us whereby only the tension-hold cycles weakened the grain boundaries which resulted in an increase of the amount of intergranular fracture that lowered the fracture toughness of the alloy. It is clear from this study that under certain elevated-temperature loading conditions, the fracture toughness of a precipitation-strengthened alloy can deteriorate long before the alloy will approach the end of its fatigue life.

4. Conclusion

Elevated-temperature symmetric reverse cyclic loading did not cause any changes in the fracture toughness of a polycrystalline precipitation-hardened aluminium alloy type 2618-T61 which was tested at 150 °C. Reverse cyclic loading with tension-hold caused a reduction in fracture toughness of the same alloy due to weakening of its grain boundaries.

References

1. A. ARBEL, *Scripta Metall.* **13** (1979) 1109.
2. A. ARBEL and C. S. PANDE, *J. Mater. Sci.* **23** (1988) 3375.
3. D. GAN, *Met. Trans.* **13A** (1982) 2155.
4. D. BOBROW, A. ARBEL and D. ELIEZER, to be published.
5. *Idem.*, *Scripta Metall.* **22** (1988) 1503.
6. G. SUCCOP, R. T. BUBSEY, M. H. JONES and W. F. BROWN Jr, in "Developments in Fracture Mechanics Tests Methods Standardization", ASTM STP 632 (American Society for Testing and Materials, Philadelphia, Pennsylvania, 1977) p. 153.
7. S. BAIK and R. RAJ, *Metall. Trans.* **13A** (1982) 1215.

Received 12 September 1989
and accepted 9 April 1990